

**THERMATEC**   
THERMAL SPRAY DIVISION OF AMERICAN TORCH TIP

BAYSTATE<sup>®</sup>  
EUTECTIC<sup>®</sup>  
GTV<sup>®</sup>  
METCO<sup>®</sup>  
METALISATION<sup>®</sup>  
NORTON<sup>®</sup>  
PTA<sup>®</sup>  
SMARTARC<sup>®</sup>  
STELLITE<sup>®</sup>  
TATA<sup>®</sup>/PRAXAIR<sup>®</sup>THERMACH  
THERMION<sup>®</sup>  
COLOMONOV<sup>®</sup>

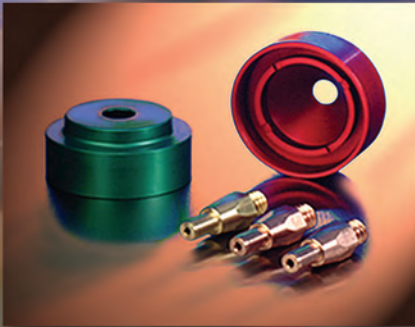

YOUR SUPER SOURCE FOR CONSUMABLE REPLACEMENT PARTS

**THERMATEC**  
THERMAL SPRAY DIVISION OF AMERICAN TORCH TIP

**AMERICAN TORCH TIP ATTC**



316

**BAYSTATE®**

*Baystate® Plasma Gun*

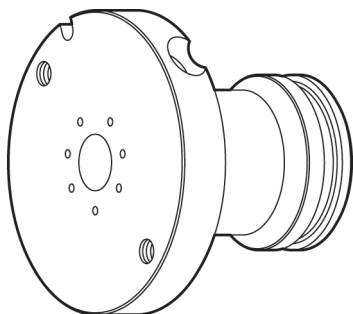

**Nozzle**  
901065



**O-Ring**  
5406006

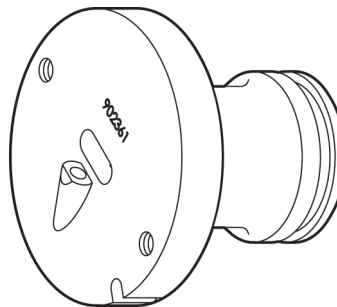

**Nozzle**  
902361



**O-Ring**  
5406006

**THERMAL**

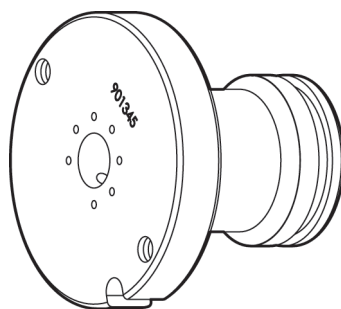

**Nozzle**  
901345



**O-Ring**  
5406006

**Not Sown**  
902352-1 Cathode

*PG Systems*

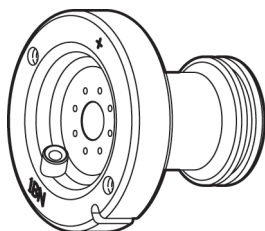

**Nozzle**  
TPA-1BN-002

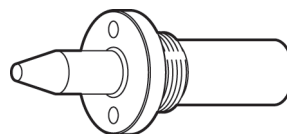

**Electrode**  
TPA-1400G-011G

American Torch Tip Company (ATTC) is in no way affiliated with above-named manufacturer. References to above-named machines, torches, and numbers are for your reference only. Most parts advertised for sale are made by or for ATTC. Other parts, as indicated, are original parts manufactured by above-named, original equipment manufacturer (OEM) and are simply being resold by ATTC. Footnotes: \* = OEM; # or ‡ = ATTC IS LICENSED TO MAKE AND SELL THIS PART BY NAMED MANUFACTURER; ATTC, ATT SUFFIX, OR - = THIS PART IS AN ORIGINAL ATTC DESIGN AND IS NOT MANUFACTURED IDENTICAL TO THE OEM DESIGN; © INDICATES A REGISTERED TRADEMARK, TRADE NAME, OR PRODUCT NAME OF THE ABOVE-NAMED COMPANY. © COPYRIGHT 2011, AMERICAN TORCH TIP COMPANY

941-753-7557 • FAX: 941-753-6917 • 800 342-8477 • SALES@ATTCUSA.COM • WWW.AMERICANTORCHTIP.COM

317

**EUTECTIC®**

*Eutectic® Terojet®*



Barrel Assembly  
600700



O-Ring  
230274

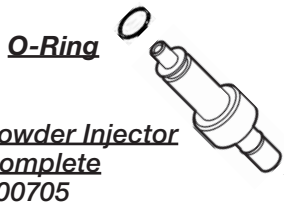

Powder Injector Complete  
600705



O-Ring  
230275



O-Ring  
230275

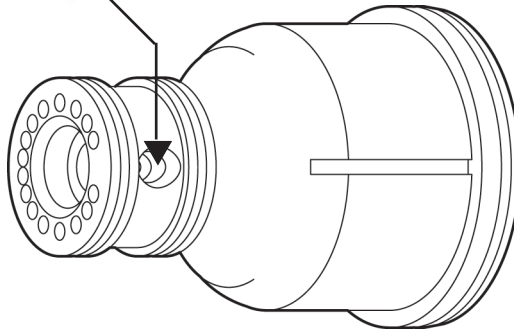

Combustion Chamber  
600702



O-Ring  
230276

**THERMAL**

American Torch Tip Company (ATTC) is in no way affiliated with above-named manufacturer. References to above-named machines, torches, and numbers are for your reference only. Most parts advertised for sale are made by or for ATTC. Other parts, as indicated, are original parts manufactured by above-named, original equipment manufacturer (OEM) and are simply being resold by ATTC. Footnotes: \* = OEM; # or † = ATTC IS LICENSED TO MAKE AND SELL THIS PART BY NAMED MANUFACTURER; ATTC, ATT SUFFIX, OR - = THIS PART IS AN ORIGINAL ATTC DESIGN AND IS NOT MANUFACTURED IDENTICAL TO THE OEM DESIGN; ® INDICATES A REGISTERED TRADEMARK, TRADE NAME, OR PRODUCT NAME OF THE ABOVE-NAMED COMPANY. © COPYRIGHT 2011, AMERICAN TORCH TIP COMPANY

YOUR SUPER SOURCE FOR CONSUMABLE REPLACEMENT PARTS

**THERMATEC**  
THERMAL SPRAY DIVISION OF AMERICAN TORCH TIP

**AMERICAN TORCH TIP ATTC**



318

**EUTECTIC®**

*Eutectic® Terodyn®*

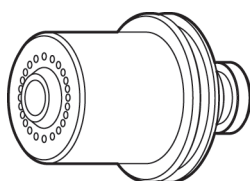

Nozzle  
RL200M

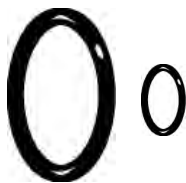

O-Ring Pkg.  
84355

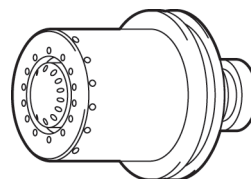

Nozzle  
RL210W

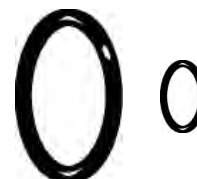

O-Ring Pkg.  
84355



Nozzle  
RL210M

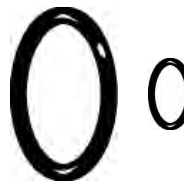

O-Ring Pkg.  
84355

THERMAL

American Torch Tip Company (ATTC) is in no way affiliated with above-named manufacturer. References to above-named machines, torches, and numbers are for your reference only. Most parts advertised for sale are made by or for ATTC. Other parts, as indicated, are original parts manufactured by above-named, original equipment manufacturer (OEM) and are simply being resold by ATTC. Footnotes: \* = OEM; # or † = ATTC IS LICENSED TO MAKE AND SELL THIS PART BY NAMED MANUFACTURER; ATTC, ATT SUFFIX, OR - = THIS PART IS AN ORIGINAL ATTC DESIGN AND IS NOT MANUFACTURED IDENTICAL TO THE OEM DESIGN; ® INDICATES A REGISTERED TRADEMARK, TRADE NAME, OR PRODUCT NAME OF THE ABOVE-NAMED COMPANY. © COPYRIGHT 2011, AMERICAN TORCH TIP COMPANY

941-753-7557 • FAX: 941-753-6917 • 800 342-8477 • SALES@ATTCUSA.COM • WWW.AMERICANTORCHTIP.COM

**THERMATEC**  
THERMAL SPRAY DIVISION OF AMERICAN TORCH TIP

YOUR SOURCE FOR CONSUMABLE REPLACEMENT PARTS



319

GTV®

GTV® K2®

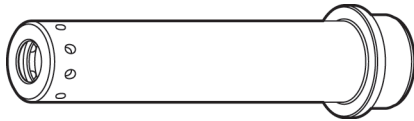

Intermediate Section  
780.120-150



Expansion Nozzle  
780.150-150

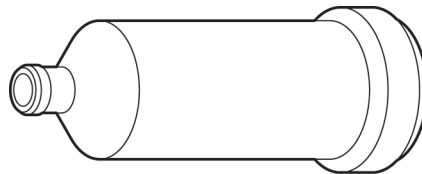

Combustion Chamber  
780.160

THERMAL

American Torch Tip Company (ATTC) is in no way affiliated with above-named manufacturer. References to above-named machines, torches, and numbers are for your reference only. Most parts advertised for sale are made by or for ATTC. Other parts, as indicated, are original parts manufactured by above-named, original equipment manufacturer (OEM) and are simply being resold by ATTC. Footnotes: \* = OEM; # or † = ATTC IS LICENSED TO MAKE AND SELL THIS PART BY NAMED MANUFACTURER; ATTC, ATT SUFFIX, OR - = THIS PART IS AN ORIGINAL ATTC DESIGN AND IS NOT MANUFACTURED IDENTICAL TO THE OEM DESIGN; © INDICATES A REGISTERED TRADEMARK, TRADE NAME, OR PRODUCT NAME OF THE ABOVE-NAMED COMPANY. © COPYRIGHT 2011, AMERICAN TORCH TIP COMPANY

941-753-7557 • FAX:941-753-6917 • 800 342-8477 • SALES@ATTCUSA.COM • WWW.AMERICANTORCHTIP.COM





320

**METCO®**

**Metco® Diamond Jet**

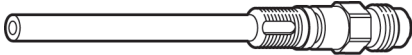

**Powder Feed Hose Fitting**  
DJ10

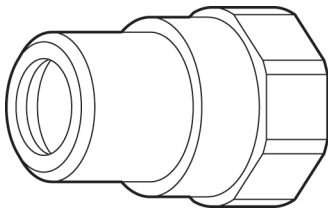

**Air Cap Body**  
DJ2721

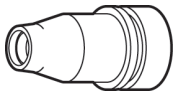

**C Shell**  
DJ17-C

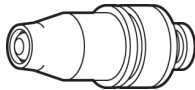

**Nozzle Assy**  
DJ7-7C

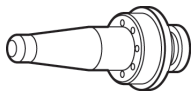

**#7 Insert Propane**  
DJ18-7

**Not Shown**  
DJ61 Gun Body O-Ring  
CV-8L Check Valve  
CV-7R Check Valve

**Propylene**

**Not Shown**  
DJ6 Nozzle Nut

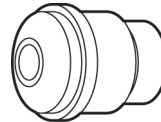

**Air Cap**  
DJ3-2

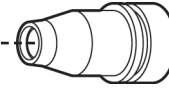

**Nozzle Shell**  
DJ17-A



**O-Ring**  
DJ108

**Propane**

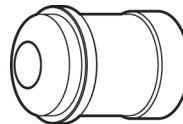

**Air Cap**  
MVG4

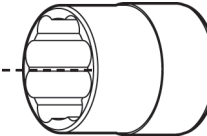

**Nozzle Nut**  
MVG7

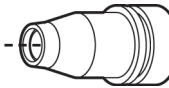

**Nozzle Shell**  
MVG17-A



**O-Ring**  
DJ108

**Propylene Propane**

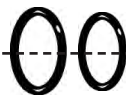

**O-Ring** **O-Ring**  
DJ77 DJ2611

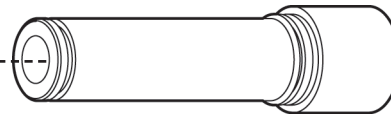

**Extended Air Cap**  
DJ2701  
DJ2702

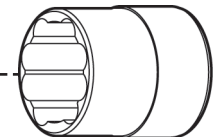

**Nozzle Nut**  
DJ2706

**Hydrogen**

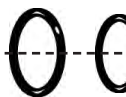

**O-Ring** **O-Ring**  
DJ77 DJ2611

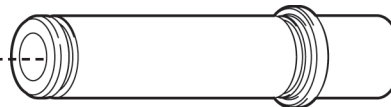

**Extended Air Cap**  
DJ2603

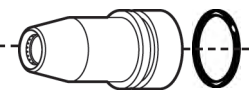

**Nozzle Shell**  
DJ17-8

American Torch Tip Company (ATTC) is in no way affiliated with above-named manufacturer. References to above-named machines, torches, and numbers are for your reference only. Most parts advertised for sale are made by or for ATTC. Other parts, as indicated, are original parts manufactured by above-named, original equipment manufacturer (OEM) and are simply being resold by ATTC. Footnotes: \* = OEM; # or † = ATTC IS LICENSED TO MAKE AND SELL THIS PART BY NAMED MANUFACTURER; ATTC, ATT SUFFIX, OR -- THIS PART IS AN ORIGINAL ATTC DESIGN AND IS NOT MANUFACTURED IDENTICAL TO THE OEM DESIGN; © INDICATES A REGISTERED TRADEMARK, TRADE NAME, OR PRODUCT NAME OF THE ABOVE-NAMED COMPANY. © COPYRIGHT 2011, AMERICAN TORCH TIP COMPANY

Metco® Diamond Jet

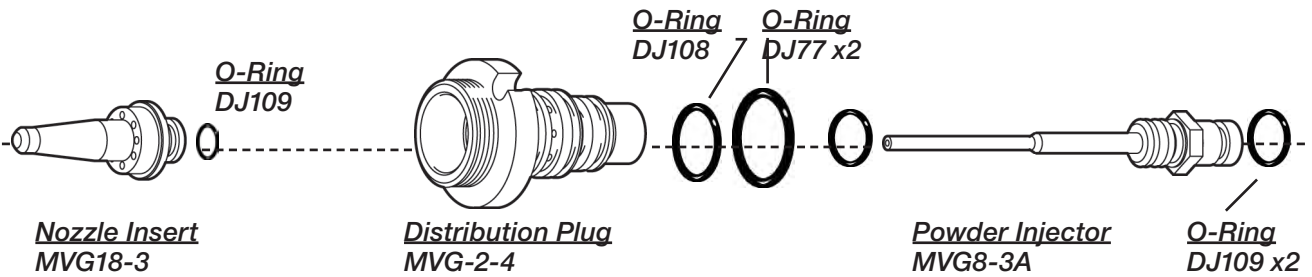
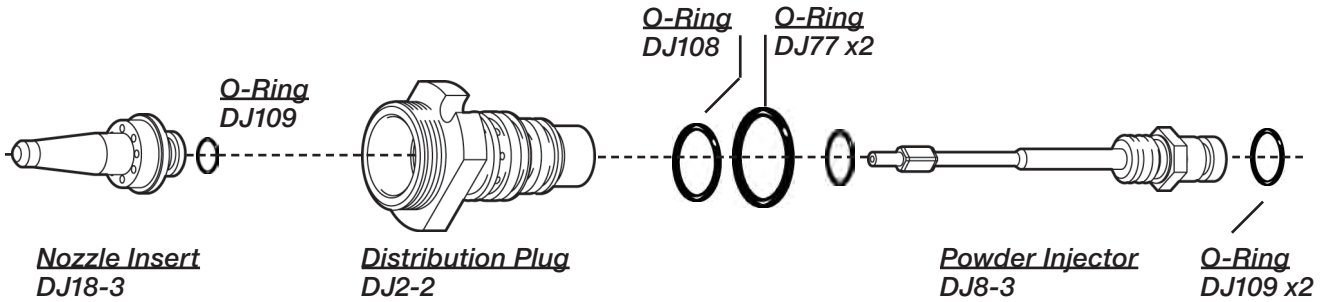

**THERMAL**

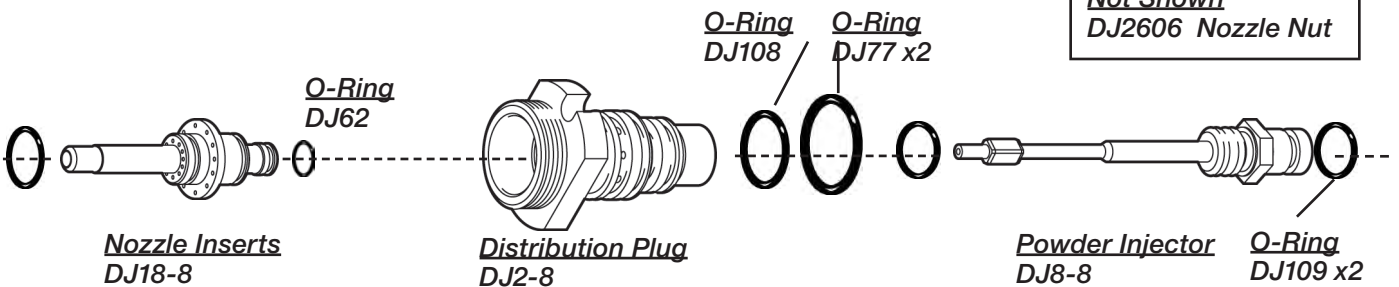
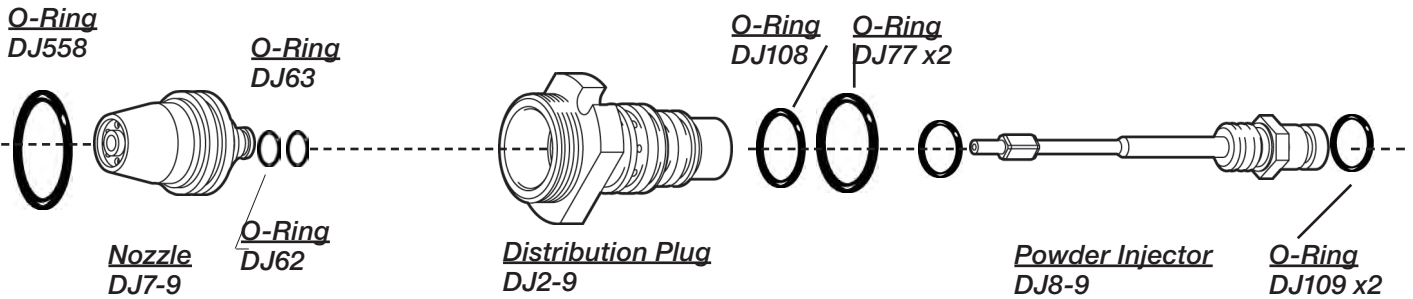

American Torch Tip Company (ATTC) is in no way affiliated with above-named manufacturer. References to above-named machines, torches, and numbers are for your reference only. Most parts advertised for sale are made by or for ATTC. Other parts, as indicated, are original parts manufactured by above-named, original equipment manufacturer (OEM) and are simply being resold by ATTC. Footnotes: \* = OEM; # or † = ATTC IS LICENSED TO MAKE AND SELL THIS PART BY NAMED MANUFACTURER; ATTC, ATT SUFFIX, OR - = THIS PART IS AN ORIGINAL ATTC DESIGN AND IS NOT MANUFACTURED IDENTICAL TO THE OEM DESIGN; © INDICATES A REGISTERED TRADEMARK, TRADE NAME, OR PRODUCT NAME OF THE ABOVE-NAMED COMPANY. © COPYRIGHT 2011, AMERICAN TORCH TIP COMPANY

YOUR SUPER SOURCE FOR CONSUMABLE REPLACEMENT PARTS

**THERMATEC**  
THERMAL SPRAY DIVISION OF AMERICAN TORCH TIP

**AMERICAN TORCH TIP ATTC**



322

**METCO®**

Metco® 10E

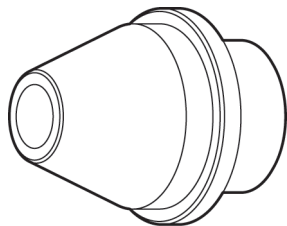

Air Cap  
10E3-EC

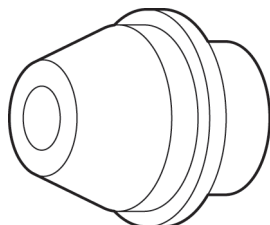

Air Cap  
10E3-C

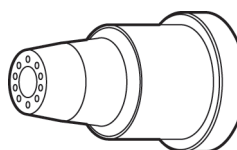

Nozzle  
10E7A-1/8

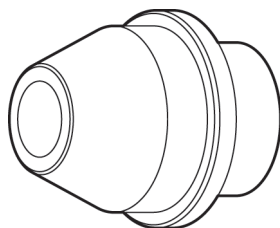

Air Cap  
10E3-EA

THERMAL

Metco® 11E



O-Ring  
11E108

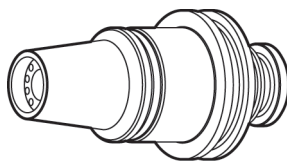

Nozzle  
11E7-15



O-Ring  
11E109

American Torch Tip Company (ATTC) is in no way affiliated with above-named manufacturer. References to above-named machines, torches, and numbers are for your reference only. Most parts advertised for sale are made by or for ATTC. Other parts, as indicated, are original parts manufactured by above-named, original equipment manufacturer (OEM) and are simply being resold by ATTC. Footnotes: \* = OEM; # or ‡ = ATTC IS LICENSED TO MAKE AND SELL THIS PART BY NAMED MANUFACTURER; ATTC, ATT SUFFIX, OR - = THIS PART IS AN ORIGINAL ATTC DESIGN AND IS NOT MANUFACTURED IDENTICAL TO THE OEM DESIGN; ® INDICATES A REGISTERED TRADEMARK, TRADE NAME, OR PRODUCT NAME OF THE ABOVE-NAMED COMPANY. © COPYRIGHT 2011, AMERICAN TORCH TIP COMPANY

941-753-7557 • FAX: 941-753-6917 • 800 342-8477 • SALES@ATTCUSA.COM • WWW.AMERICANTORCHTIP.COM

**THERMATEC**  
THERMAL SPRAY DIVISION OF AMERICAN TORCH TIP



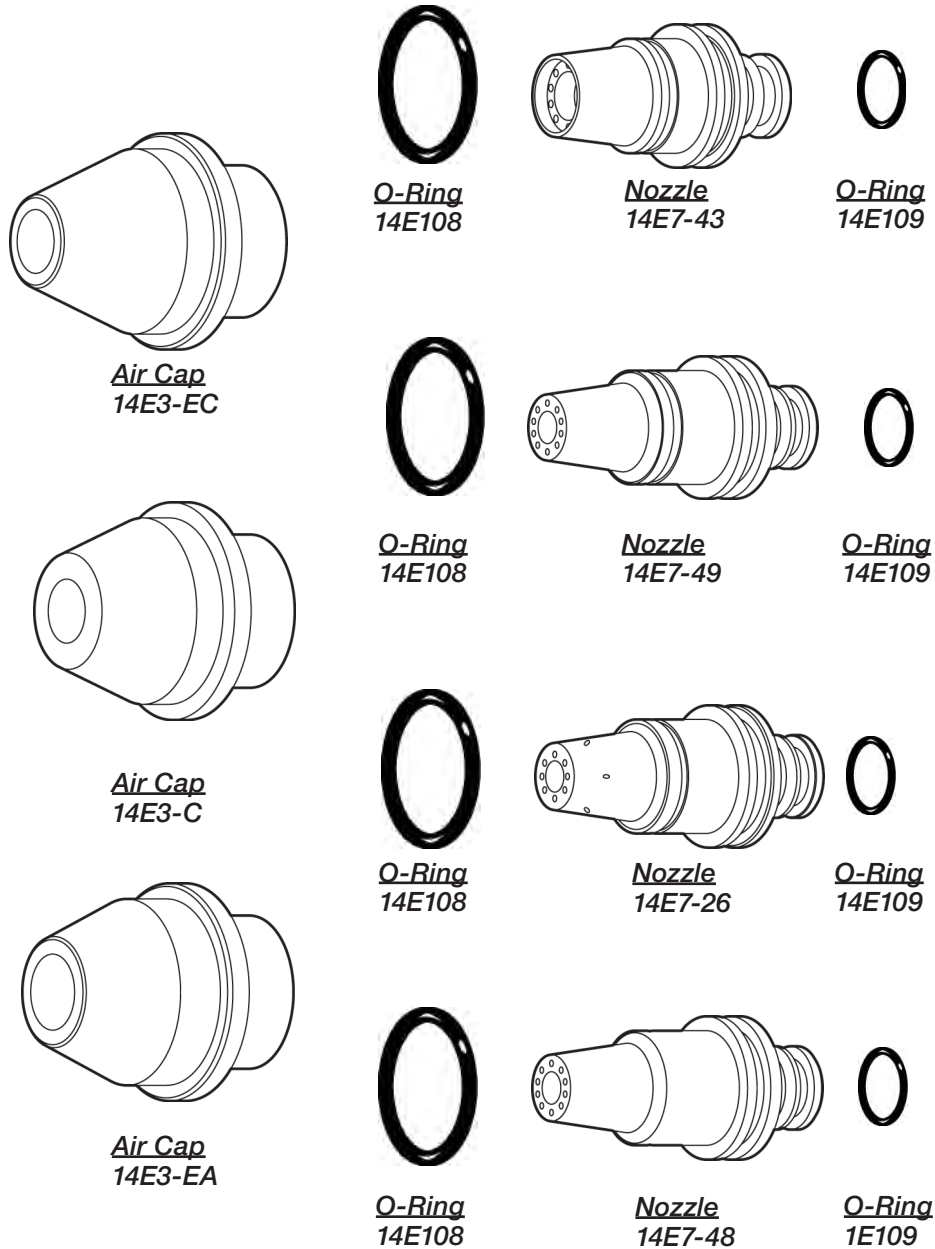

**Not Shown**  
**14E7-45 Non-load Nozzle**

**THERMAL**

American Torch Tip Company (ATTC) is in no way affiliated with above-named manufacturer. References to above-named machines, torches, and numbers are for your reference only. Most parts advertised for sale are made by or for ATTC. Other parts, as indicated, are original parts manufactured by above-named, original equipment manufacturer (OEM) and are simply being resold by ATTC. Footnotes: \* = OEM; # or † = ATTC IS LICENSED TO MAKE AND SELL THIS PART BY NAMED MANUFACTURER; ATTC, ATT SUFFIX, OR - = THIS PART IS AN ORIGINAL ATTC DESIGN AND IS NOT MANUFACTURED IDENTICAL TO THE OEM DESIGN; ® INDICATES A REGISTERED TRADEMARK, TRADE NAME, OR PRODUCT NAME OF THE ABOVE-NAMED COMPANY. © COPYRIGHT 2011, AMERICAN TORCH TIP COMPANY



324

METCO®

Metco® 12E

THERMAL

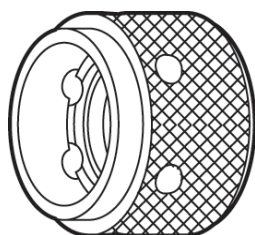

**Nozzle Nut**  
12E6

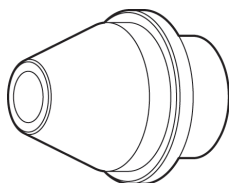

**Air Cap**  
12E3-EC

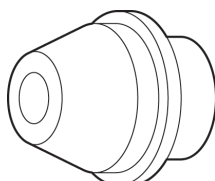

**Air Cap**  
12E3-C

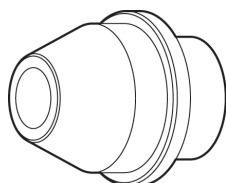

**Air Cap**  
12E3-EA



**O-Ring**  
12E108

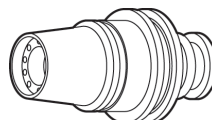

**Nozzle**  
12E7-43



**O-Ring**  
12E109



**O-Ring**  
12E108

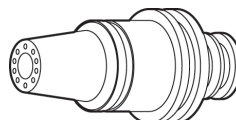

**Nozzle**  
12E7-49



**O-Ring**  
12E109



**O-Ring**  
12E108

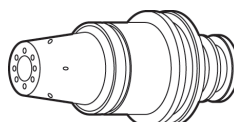

**Nozzle**  
12E7-26



**O-Ring**  
12E109



**O-Ring**  
12E108

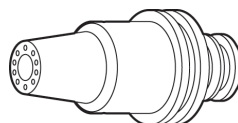

**Nozzle**  
12E7-48



**O-Ring**  
12E109

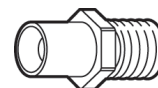

**Front Wire Guide**  
12E23-1/8

**Not Shown**

- |           |                  |
|-----------|------------------|
| 12E26     | Nozzle Nut       |
| 12E-200-2 | Siphon Plug Assy |

American Torch Tip Company (ATTC) is in no way affiliated with above-named manufacturer. References to above-named machines, torches, and numbers are for your reference only. Most parts advertised for sale are made by or for ATTC. Other parts, as indicated, are original parts manufactured by above-named, original equipment manufacturer (OEM) and are simply being resold by ATTC. Footnotes: \* = OEM; # or † = ATTC IS LICENSED TO MAKE AND SELL THIS PART BY NAMED MANUFACTURER; ATTC, ATT SUFFIX, OR - = THIS PART IS AN ORIGINAL ATTC DESIGN AND IS NOT MANUFACTURED IDENTICAL TO THE OEM DESIGN; ® INDICATES A REGISTERED TRADEMARK, TRADE NAME, OR PRODUCT NAME OF THE ABOVE-NAMED COMPANY. © COPYRIGHT 2011, AMERICAN TORCH TIP COMPANY

Insulator Assembly  
2M189

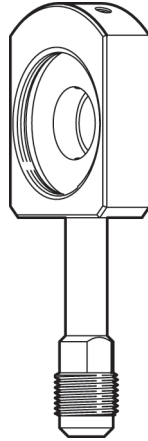

Front Gun Body  
2M187

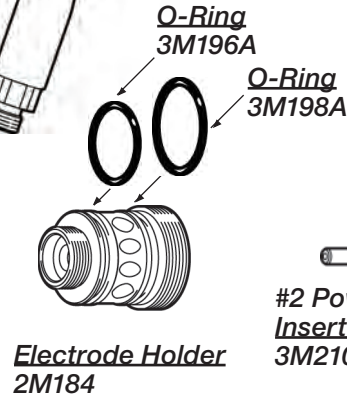
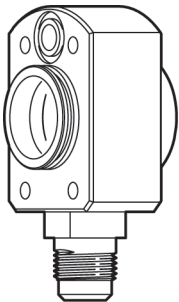

Not Shown  
3M206A O-Ring  
3M195A O-Ring  
3M181A O-Ring  
3M11F Electrode

THERMAL

American Torch Tip Company (ATTC) is in no way affiliated with above-named manufacturer. References to above-named machines, torches, and numbers are for your reference only. Most parts advertised for sale are made by or for ATTC. Other parts, as indicated, are original parts manufactured by above-named, original equipment manufacturer (OEM) and are simply being resold by ATTC. Footnotes: \* = OEM; # or † = ATTC IS LICENSED TO MAKE AND SELL THIS PART BY NAMED MANUFACTURER; ATTC, ATT SUFFIX, OR - = THIS PART IS AN ORIGINAL ATTC DESIGN AND IS NOT MANUFACTURED IDENTICAL TO THE OEM DESIGN; ® INDICATES A REGISTERED TRADEMARK, TRADE NAME, OR PRODUCT NAME OF THE ABOVE-NAMED COMPANY. © COPYRIGHT 2011, AMERICAN TORCH TIP COMPANY

YOUR SUPER SOURCE FOR CONSUMABLE REPLACEMENT PARTS

**THERMATEC**  
THERMAL SPRAY DIVISION OF AMERICAN TORCH TIP

**AMERICAN TORCH TIP ATTC**



326

METCO®

Metco® 3MBII



O-Ring

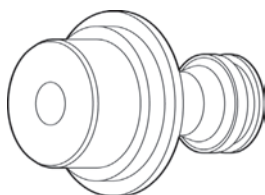

Nozzle  
3MG525B  
3MB530B-ATTC Long Life  
3MB531B-ATTC Long Life  
3MB532B-ATTC Long Life  
3MB533B-ATTC Long Life  
3MB530B  
3MB531B  
3MB532B  
3MB533B



O-Ring



Argon Ring  
3MB260

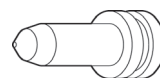

Electrode  
3MB63



O-Ring

Not Shown  
3MB187 Front Gun Body  
3MB189 Insulator Assembly

THERMAL

Metco® 3MBT

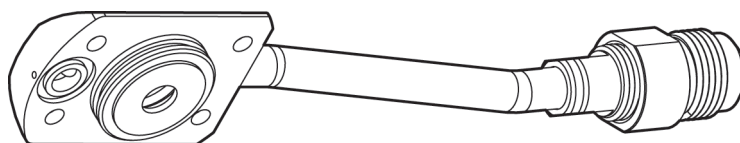

Gun Body Rear 30°  
3MBT-392

American Torch Tip Company (atcc) is in no way affiliated with above-named manufacturer. References to above-named machines, torches, and numbers are for your reference only. Most parts advertised for sale are made by or for ATTC. Other parts, as indicated, are original parts manufactured by above-named, original equipment manufacturer (OEM) and are simply being resold by ATTC. Footnotes: \* = OEM; # or † = ATTC IS LICENSED TO MAKE AND SELL THIS PART BY NAMED MANUFACTURER; ATTC, ATT SUFFIX, OR - = THIS PART IS AN ORIGINAL ATTC DESIGN AND IS NOT MANUFACTURED IDENTICAL TO THE OEM DESIGN; ® INDICATES A REGISTERED TRADEMARK, TRADE NAME, OR PRODUCT NAME OF THE ABOVE-NAMED COMPANY. © COPYRIGHT 2011, AMERICAN TORCH TIP COMPANY

941-753-7557 • FAX: 941-753-6917 • 800 342-8477 • SALES@ATTCUSA.COM • WWW.AMERICANTORCHTIP.COM

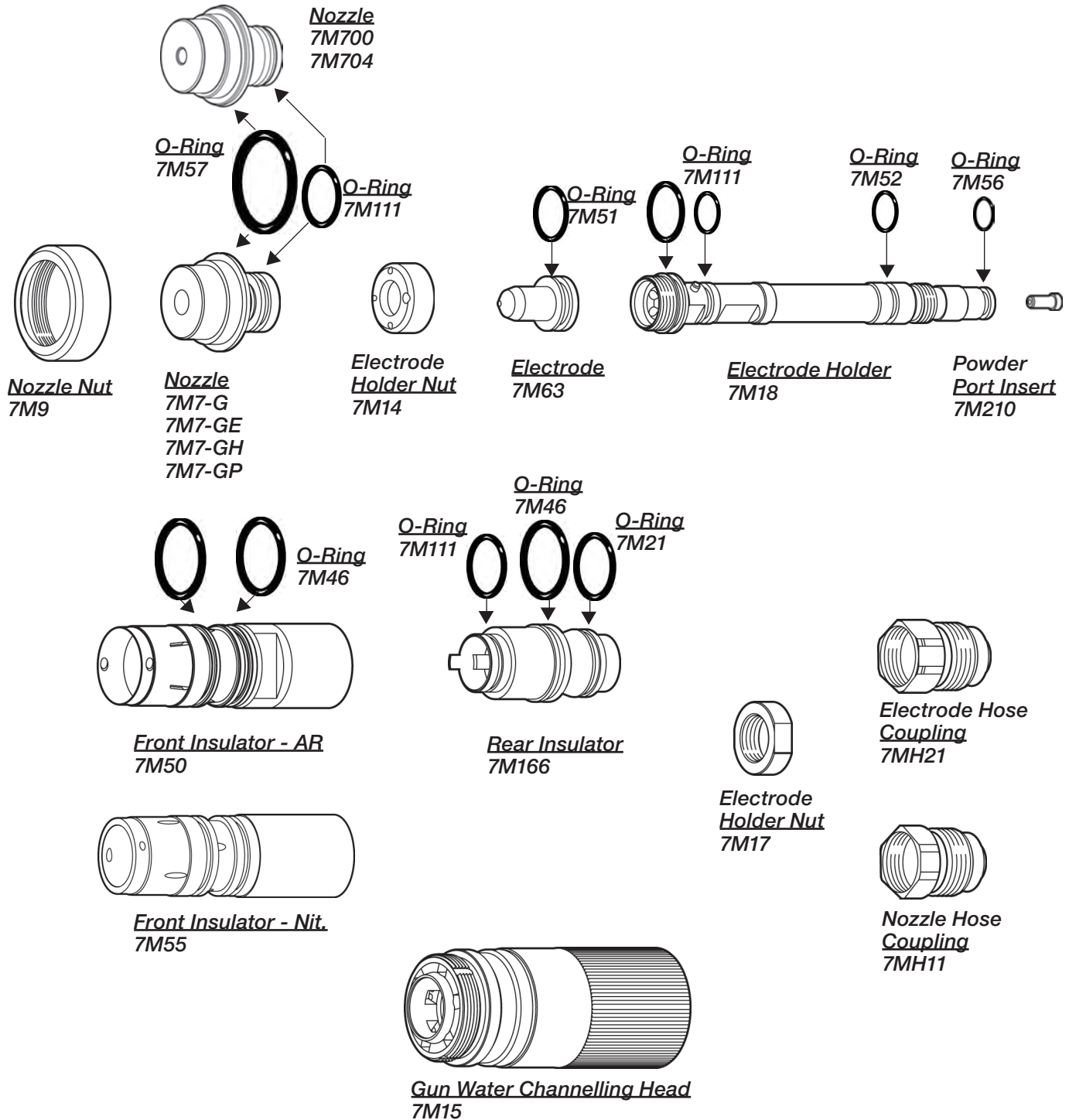

**THERMAL**

American Torch Tip Company (ATTC) is in no way affiliated with above-named manufacturer. References to above-named machines, torches, and numbers are for your reference only. Most parts advertised for sale are made by or for ATTC. Other parts, as indicated, are original parts manufactured by above-named, original equipment manufacturer (OEM) and are simply being resold by ATTC. Footnotes: \* = OEM; # or † = ATTC IS LICENSED TO MAKE AND SELL THIS PART BY NAMED MANUFACTURER; ATTC, ATT SUFFIX, OR - = THIS PART IS AN ORIGINAL ATTC DESIGN AND IS NOT MANUFACTURED IDENTICAL TO THE OEM DESIGN; ® INDICATES A REGISTERED TRADEMARK, TRADE NAME, OR PRODUCT NAME OF THE ABOVE-NAMED COMPANY. © COPYRIGHT 2011, AMERICAN TORCH TIP COMPANY



328

**METCO®**

**Metco® 9MB**

**Not Shown**  
9MB50 Front Insulator Assy.  
9MB297 O-Ring  
9MB852 Wrench

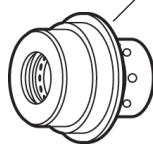

**Nozzle Shell**  
9MB-730C  
9MB-731C  
9MB-732C  
9MB-733C

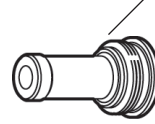

**Nozzle Body**  
9MB-730B  
9MB-731B  
9MB-732B  
9MB-733B

**Nozzle Assembly**  
9MB-730A  
9MB-731A  
9MB-732A  
9MB-733A

**THERMAL**

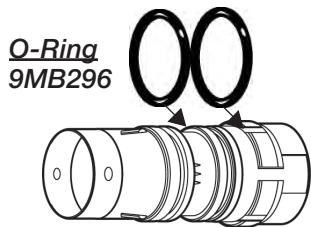
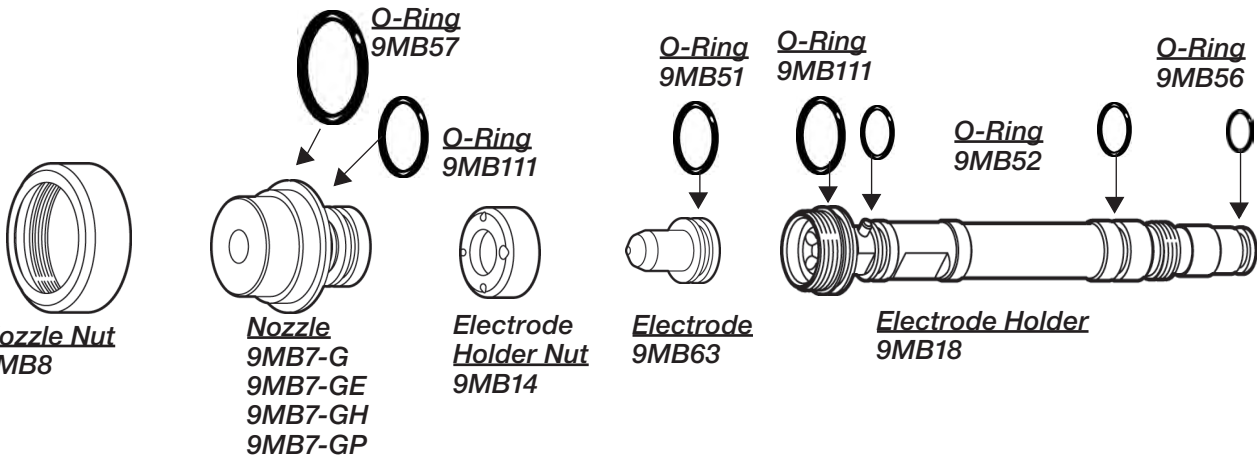

**Front Insulator Nut**  
9MB55

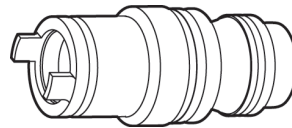

**Rear Insulator**  
9MB166



**Electrode Holder Nut**  
9MB17



**Electrode Hose Coupling**  
9MB21



**Nozzle Hose Coupling**  
9MB11

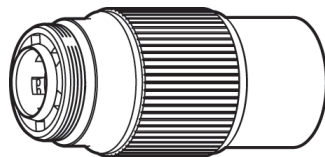

**Water Channeling Haed**  
9MB15

American Torch Tip Company (ATTC) is in no way affiliated with above-named manufacturer. References to above-named machines, torches, and numbers are for your reference only. Most parts advertised for sale are made by or for ATTC. Other parts, as indicated, are original parts manufactured by above-named, original equipment manufacturer (OEM) and are simply being resold by ATTC. Footnotes: \* = OEM; # or † = ATTC IS LICENSED TO MAKE AND SELL THIS PART BY NAMED MANUFACTURER; ATTC, ATT SUFFIX, OR - THIS PART IS AN ORIGINAL ATTC DESIGN AND IS NOT MANUFACTURED IDENTICAL TO THE OEM DESIGN; © INDICATES A REGISTERED TRADEMARK, TRADE NAME, OR PRODUCT NAME OF THE ABOVE-NAMED COMPANY. © COPYRIGHT 2011, AMERICAN TORCH TIP COMPANY

329

**METCO®**

Metco® 10MB

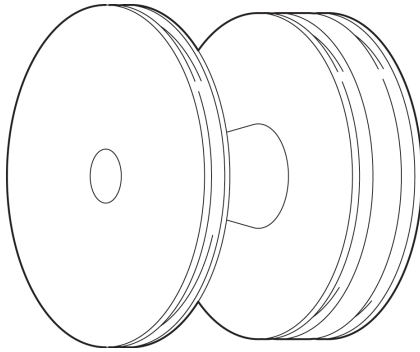

**Nozzle**  
10MB-830-2



**O-Ring**  
10MB79

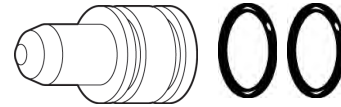

**Electrode**  
10MB163

**O-Ring**  
10MB51

**THERMAL**

Metco® 11MB

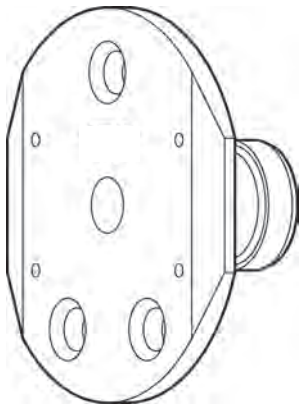

**Nozzle**  
11MB112

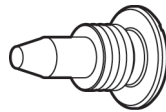

**Electrode**  
11MB25

Metco® 2RG

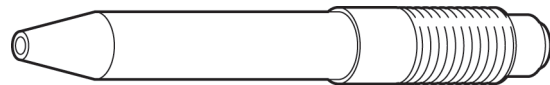

**Contact Tube**  
2RG22-11 11Ga  
2RG22-14 14Ga

American Torch Tip Company (ATTC) is in no way affiliated with above-named manufacturer. References to above-named machines, torches, and numbers are for your reference only. Most parts advertised for sale are made by or for ATTC. Other parts, as indicated, are original parts manufactured by above-named, original equipment manufacturer (OEM) and are simply being resold by ATTC. Footnotes: \* = OEM; # or † = ATTC IS LICENSED TO MAKE AND SELL THIS PART BY NAMED MANUFACTURER; ATTC, ATT SUFFIX, OR - = THIS PART IS AN ORIGINAL ATTC DESIGN AND IS NOT MANUFACTURED IDENTICAL TO THE OEM DESIGN; ® INDICATES A REGISTERED TRADEMARK, TRADE NAME, OR PRODUCT NAME OF THE ABOVE-NAMED COMPANY. © COPYRIGHT 2011, AMERICAN TORCH TIP COMPANY

YOUR SUPER SOURCE FOR CONSUMABLE REPLACEMENT PARTS

**THERMATEC**  
THERMAL SPRAY DIVISION OF AMERICAN TORCH TIP

**AMERICAN TORCH TIP ATTC**



**330**

**METCO®**

*Metco® 5P*

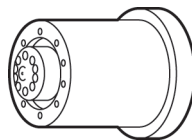

Nozzle  
5P7-G

**THERMAL**

*Metco® 5Pii*

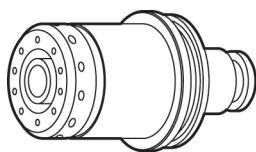

Nozzle  
5P7B-F



O-Ring  
5P108



O-Ring  
5P107



Baffle  
Brass  
5P518

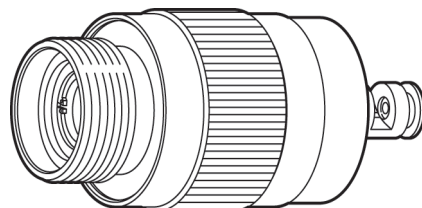

Siphon Plug Assy.  
5P585



Screw  
5P520

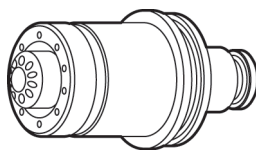

Nozzle  
5P7B-G



O-Ring  
5P108



O-Ring  
5P107

**Not Shown**  
5P84 Baffle Retaining Ring  
5P515 O-Ring, Aspirator  
5P516 O-Ring, Siphon Plug  
5P519 Sleeve

American Torch Tip Company (ATTC) is in no way affiliated with above-named manufacturer. References to above-named machines, torches, and numbers are for your reference only. Most parts advertised for sale are made by or for ATTC. Other parts, as indicated, are original parts manufactured by above-named, original equipment manufacturer (OEM) and are simply being resold by ATTC. Footnotes: \* = OEM; # or † = ATTC IS LICENSED TO MAKE AND SELL THIS PART BY NAMED MANUFACTURER; ATTC, ATT SUFFIX, OR - = THIS PART IS AN ORIGINAL ATTC DESIGN AND IS NOT MANUFACTURED IDENTICAL TO THE OEM DESIGN; ® INDICATES A REGISTERED TRADEMARK, TRADE NAME, OR PRODUCT NAME OF THE ABOVE-NAMED COMPANY. © COPYRIGHT 2011, AMERICAN TORCH TIP COMPANY

941-753-7557 • FAX: 941-753-6917 • 800 342-8477 • SALES@ATTCUSA.COM • WWW.AMERICANTORCHTIP.COM



YOUR SOURCE FOR CONSUMABLE REPLACEMENT PARTS



331

METCO®

Metco® 6P

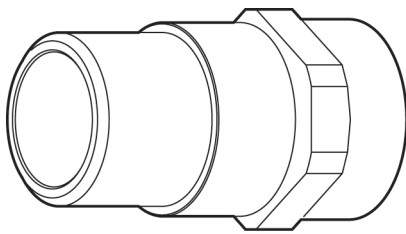

Air Cap Body  
6P117

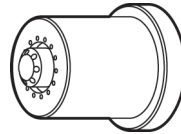

Nozzle  
6P7A-D

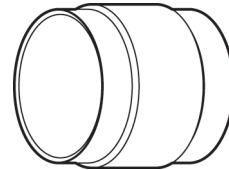

Sleeve  
6P82

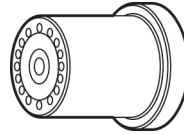

Nozzle  
6P7A-M



Retaining Ring  
6P84



Baffle  
6P83, Brass

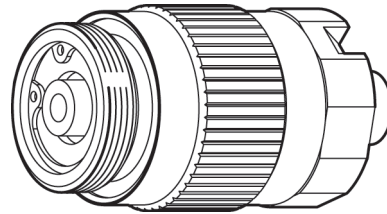

Siphon Plug  
6P200

THERMAL

American Torch Tip Company (ATTC) is in no way affiliated with above-named manufacturer. References to above-named machines, torches, and numbers are for your reference only. Most parts advertised for sale are made by or for ATTC. Other parts, as indicated, are original parts manufactured by above-named, original equipment manufacturer (OEM) and are simply being resold by ATTC. Footnotes: \* = OEM, # or † = ATTC IS LICENSED TO MAKE AND SELL THIS PART BY NAMED MANUFACTURER, ATTC, ATT SUFFIX, OR - = THIS PART IS AN ORIGINAL ATTC DESIGN AND IS NOT MANUFACTURED IDENTICAL TO THE OEM DESIGN; ® INDICATES A REGISTERED TRADEMARK, TRADE NAME, OR PRODUCT NAME OF THE ABOVE-NAMED COMPANY. © COPYRIGHT 2011, AMERICAN TORCH TIP COMPANY

941-753-7557 • FAX:941-753-6917 • 800 342-8477 • SALES@ATTCUSA.COM • WWW.AMERICANTORCHTIP.COM





332

METCO®

Metco® 6P11

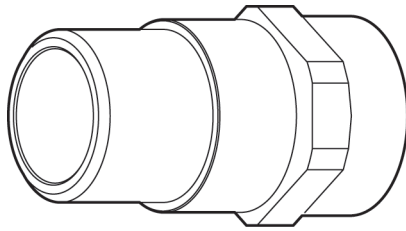

Air Cap Body  
6P117

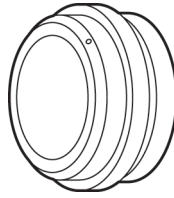

Air Cap  
6P4

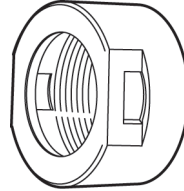

Nozzle Nut  
6P525

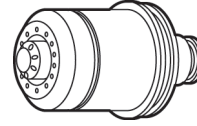

Nozzle  
6P7C-D



Q-Ring  
6P218



Q-Ring  
6P217

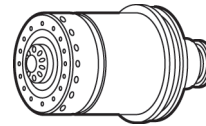

Nozzle  
6P7C-K



Q-Ring  
6P218



Q-Ring  
6P217

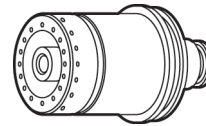

Nozzle  
6P7C-M



Q-Ring  
6P218



Q-Ring  
6P217



Retaining Ring  
6P84



Baffle  
6P518

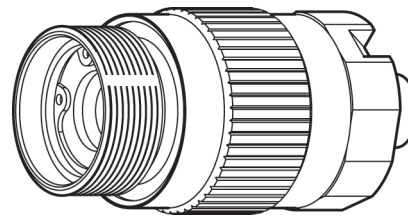

Siphon Plug  
6P605

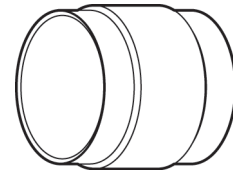

Sleeve  
6P82

THERMAL

American Torch Tip Company (ATTC) is in no way affiliated with above-named manufacturer. References to above-named machines, torches, and numbers are for your reference only. Most parts advertised for sale are made by or for ATTC. Other parts, as indicated, are original parts manufactured by above-named, original equipment manufacturer (OEM) and are simply being resold by ATTC. Footnotes: \* = OEM; # or † = ATTC IS LICENSED TO MAKE AND SELL THIS PART BY NAMED MANUFACTURER; ATTC, ATT SUFFIX, OR - = THIS PART IS AN ORIGINAL ATTC DESIGN AND IS NOT MANUFACTURED IDENTICAL TO THE OEM DESIGN; ® INDICATES A REGISTERED TRADEMARK, TRADE NAME, OR PRODUCT NAME OF THE ABOVE-NAMED COMPANY. © COPYRIGHT 2011, AMERICAN TORCH TIP COMPANY

**333**

**METCO®**

Metco® 6RG



Contact Tip

- 6RG39 - 2mm, LL
- 6RG46 - 14 GA
- 6RG47 - 11 GA
- 6RG48 - 2mm
- 6RG63 - 14 GA, LL
- 6RG68 - 11 GA, LL

Metco® F4

**THERMAL**

Noz/Elec. Assy  
300.003

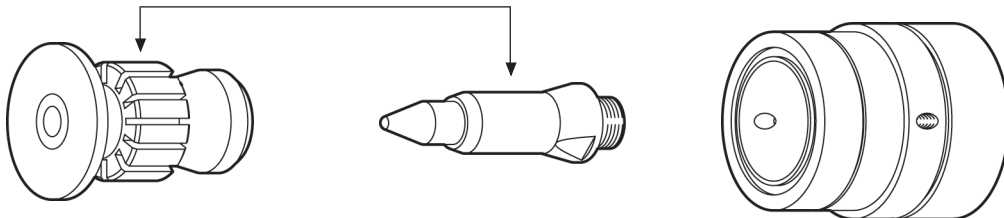

Nozzle Tung. Inst.  
300.002-6MM  
300.002-8MM

Electrode  
300.001

Gun Body, Front  
300.006

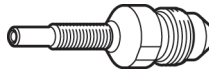

Power Injector  
300.019 1.5mm  
300.020 1.8mm  
300.021 2.0mm

American Torch Tip Company (ATTC) is in no way affiliated with above-named manufacturer. References to above-named machines, torches, and numbers are for your reference only. Most parts advertised for sale are made by or for ATTC. Other parts, as indicated, are original parts manufactured by above-named, original equipment manufacturer (OEM) and are simply being resold by ATTC. Footnotes: \* = OEM; # or † = ATTC IS LICENSED TO MAKE AND SELL THIS PART BY NAMED MANUFACTURER; ATTC, ATT SUFFIX, OR - = THIS PART IS AN ORIGINAL ATTC DESIGN AND IS NOT MANUFACTURED IDENTICAL TO THE OEM DESIGN; ® INDICATES A REGISTERED TRADEMARK, TRADE NAME, OR PRODUCT NAME OF THE ABOVE-NAMED COMPANY. © COPYRIGHT 2011, AMERICAN TORCH TIP COMPANY

YOUR SUPER SOURCE FOR CONSUMABLE REPLACEMENT PARTS

**THERMATEC**  
THERMAL SPRAY DIVISION OF AMERICAN TORCH TIP

**AMERICAN TORCH TIP ATTC**



334

**METCO®**

**Metco® F100**

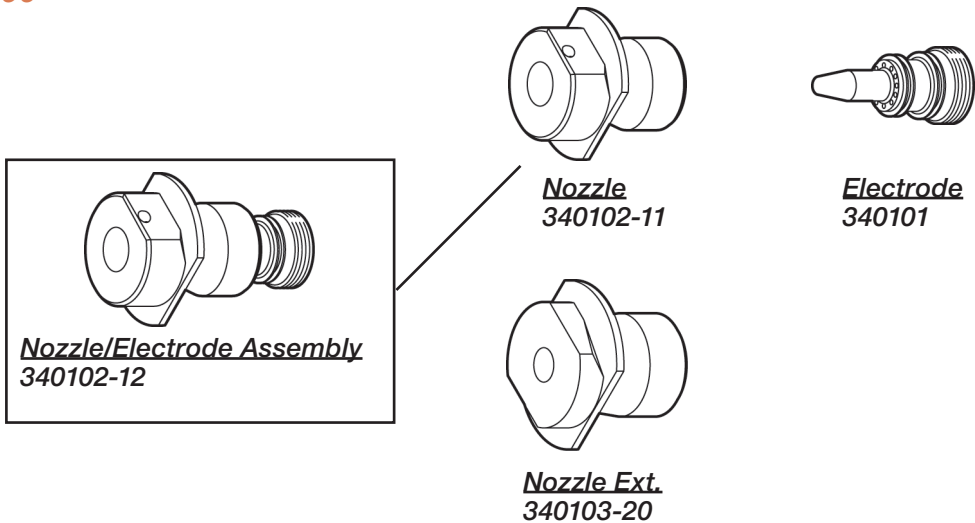

THERMAL

**Metco® 03CA**

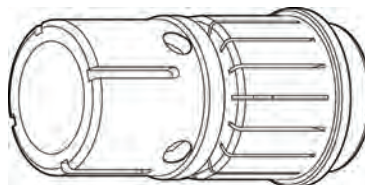

**Anode**  
03CA-141-4

**Smartarc®**



**Contact Tip**  
PPG51496 14GA, AL



**Contact Tip**  
PPG51920 14GA, LL  
PPG51921 2mm, LL

American Torch Tip Company (ATTC) is in no way affiliated with above-named manufacturer. References to above-named machines, torches, and numbers are for your reference only. Most parts advertised for sale are made by or for ATTC. Other parts, as indicated, are original parts manufactured by above-named, original equipment manufacturer (OEM) and are simply being resold by ATTC. Footnotes: \* = OEM; # or † = ATTC IS LICENSED TO MAKE AND SELL THIS PART BY NAMED MANUFACTURER; ATTC, ATT SUFFIX, OR - = THIS PART IS AN ORIGINAL ATTC DESIGN AND IS NOT MANUFACTURED IDENTICAL TO THE OEM DESIGN; © INDICATES A REGISTERED TRADEMARK, TRADE NAME, OR PRODUCT NAME OF THE ABOVE-NAMED COMPANY. © COPYRIGHT 2011, AMERICAN TORCH TIP COMPANY

941-753-7557 • FAX: 941-753-6917 • 800 342-8477 • SALES@ATTCUSA.COM • WWW.AMERICANTORCHTIP.COM

YOUR SOURCE FOR CONSUMABLE REPLACEMENT PARTS



335

METALISATION®/NORTON®

Metalisation® Arcspray 140



**Contact Tube**  
7541-1.6mm

Norton® Rokide

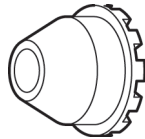

**Air Cap**  
773.3282.B 5/16"  
773.3281.B 1/4", 3/16"

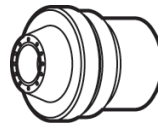

**Nozle**  
773.3279.B 1/4"  
773.3280.B 5/16"  
773.3287.B 3/16"

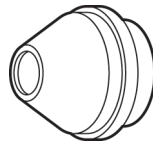

**Air Cap**  
5000258 1/4"

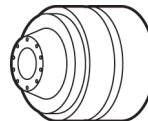

**Nozzle**  
500103A 1/4"

**Not Shown**

773.3051.B Main Body Air Cap  
773.3058.B Mixing Head

American Torch Tip Company (ATTC) is in no way affiliated with above-named manufacturer. References to above-named machines, torches, and numbers are for your reference only. Most parts advertised for sale are made by or for ATTC. Other parts, as indicated, are original parts manufactured by above-named, original equipment manufacturer (OEM) and are simply being resold by ATTC. Footnotes: \* = OEM; # or † = ATTC IS LICENSED TO MAKE AND SELL THIS PART BY NAMED MANUFACTURER; ATTC, ATT SUFFIX, OR - = THIS PART IS AN ORIGINAL ATTC DESIGN AND IS NOT MANUFACTURED IDENTICAL TO THE OEM DESIGN; ® INDICATES A REGISTERED TRADEMARK, TRADE NAME, OR PRODUCT NAME OF THE ABOVE-NAMED COMPANY. © COPYRIGHT 2011, AMERICAN TORCH TIP COMPANY

941-753-7557 • FAX:941-753-6917 • 800 342-8477 • SALES@ATTCUSA.COM • WWW.AMERICANTORCHTIP.COM

THERMAL





336

PTA/ STELLITE®

Stellite® PTA

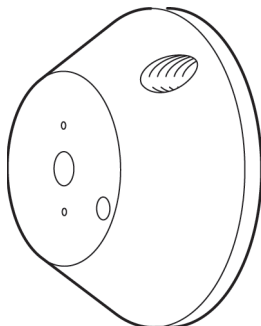

**Power Spray Orifice**

562328

Stellite® PTA 600



**Nozzle**

963822-3/16

963824-1/8

THERMAL

Stellite® Jetkote

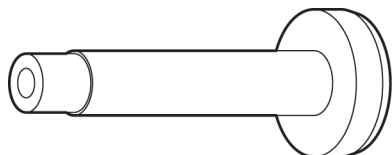

**Nozzle**

Part #	Length	I.D.
972935	6.00"	1/4
972849	6.00"	5/16
972950	9.00"	1/4
972521	9.00"	5/16

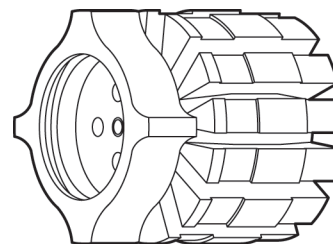

**Combustion Head**

972494 .080 OEM

972569 .052 OEM



**Combustion Chamber**

972495

American Torch Tip Company (ATTC) is in no way affiliated with above-named manufacturer. References to above-named machines, torches, and numbers are for your reference only. Most parts advertised for sale are made by or for ATTC. Other parts, as indicated, are original parts manufactured by above-named, original equipment manufacturer (OEM) and are simply being resold by ATTC. Footnotes: \* = OEM; # or † = ATTC IS LICENSED TO MAKE AND SELL THIS PART BY NAMED MANUFACTURER; ATTC, ATT SUFFIX, OR - = THIS PART IS AN ORIGINAL ATTC DESIGN AND IS NOT MANUFACTURED IDENTICAL TO THE OEM DESIGN; © INDICATES A REGISTERED TRADEMARK, TRADE NAME, OR PRODUCT NAME OF THE ABOVE-NAMED COMPANY. © COPYRIGHT 2011, AMERICAN TORCH TIP COMPANY

**STELLITE® Tafa®/PRAXAIR®**

*Stellite® Micostar Starweld HPH 150*



Electrode  
15191



Electrode  
963572



Electrode  
966545



Powder Nozzle#4  
966556



Plasma Nozzle  
966554

Not Shown  
966565 Shield Gas Nozzle

THERMAL

*Tafa®/Praxair® BP400*

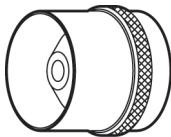

High Velocity Air Cap  
5004734



Air Cap  
5000019A



Wire Guide  
5000391 11 gauge  
5000392 14 gauge



Wire Guide  
5000981 14 gauge

Not Shown  
5005233-3 Coaxial Power Cable  
5005233-10 Coaxial Cable 10' Power  
5005233-15 Coaxial Cable 15' Power

American Torch Tip Company (ATTC) is in no way affiliated with above-named manufacturer. References to above-named machines, torches, and numbers are for your reference only. Most parts advertised for sale are made by or for ATTC. Other parts, as indicated, are original parts manufactured by above-named, original equipment manufacturer (OEM) and are simply being resold by ATTC. Footnotes: \* = OEM; # or † = ATTC IS LICENSED TO MAKE AND SELL THIS PART BY NAMED MANUFACTURER; ATTC, ATT SUFFIX, OR - = THIS PART IS AN ORIGINAL ATTC DESIGN AND IS NOT MANUFACTURED IDENTICAL TO THE OEM DESIGN; ® INDICATES A REGISTERED TRADEMARK, TRADE NAME, OR PRODUCT NAME OF THE ABOVE-NAMED COMPANY. © COPYRIGHT 2011, AMERICAN TORCH TIP COMPANY

YOUR SUPER SOURCE FOR CONSUMABLE REPLACEMENT PARTS

**THERMATEC**  
THERMAL SPRAY DIVISION OF AMERICAN TORCH TIP

**AMERICAN TORCH TIP ATTC**



338

Tafa® PRAXAIR®

Tafa® Praxair® HV2000

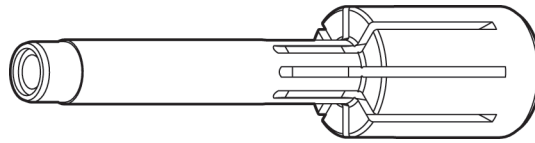

**Nozzle**  
5003411 0mm

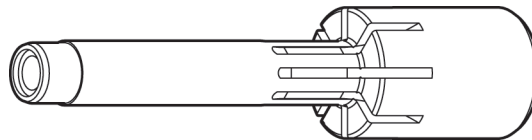

**Nozzle**  
5003218 22mm

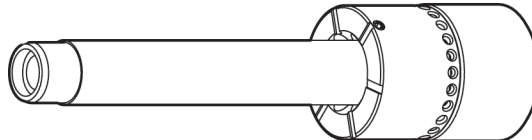

**Nozzle**  
5003219 12mm

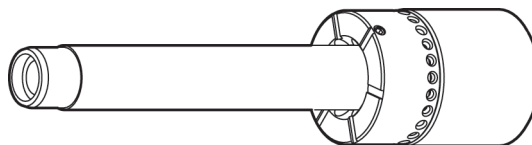

**Nozzle**  
5003185 19mm

**Not Shown**  
500217 O-Ring Kit

American Torch Tip Company (ATTC) is in no way affiliated with above-named manufacturer. References to above-named machines, torches, and numbers are for your reference only. Most parts advertised for sale are made by or for ATTC. Other parts, as indicated, are original parts manufactured by above-named, original equipment manufacturer (OEM) and are simply being resold by ATTC. Footnotes: \* = OEM; # or † = ATTC IS LICENSED TO MAKE AND SELL THIS PART BY NAMED MANUFACTURER; ATTC, ATT SUFFIX, OR - = THIS PART IS AN ORIGINAL ATTC DESIGN AND IS NOT MANUFACTURED IDENTICAL TO THE OEM DESIGN; ® INDICATES A REGISTERED TRADEMARK, TRADE NAME, OR PRODUCT NAME OF THE ABOVE-NAMED COMPANY. © COPYRIGHT 2011, AMERICAN TORCH TIP COMPANY

941-753-7557 • FAX: 941-753-6917 • 800 342-8477 • SALES@ATTCUSA.COM • WWW.AMERICANTORCHTIP.COM

**THERMATEC**  
THERMAL SPRAY DIVISION OF AMERICAN TORCH TIP

THERMAL



**Barrel Holder**

- 450863 4"
- 450864 6"
- 450865 8"

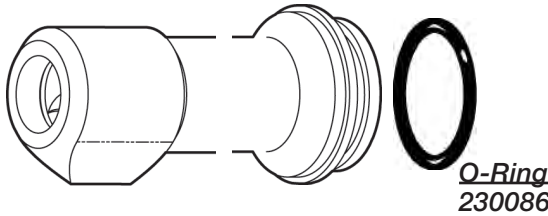

<b>Not Shown</b>	
200418 Screw	230212 O-Ring
200816 Screw	410112 Check Valve
210010 Adapter	410113 Check Valve
210077 Nipple	450779 Nut
210081 Nipple	600392 Coaxial Stab. Assy.
210145 Adapter	600401 Barrel Assembly 4"
230027 O-Ring	620178C Elbow/Nipple Assy.
230094 O-Ring	

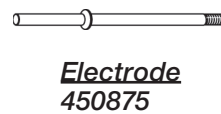
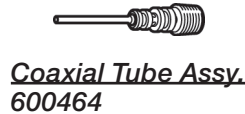
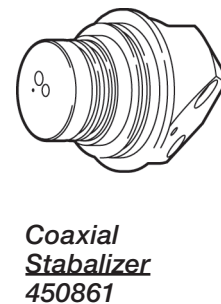
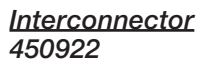
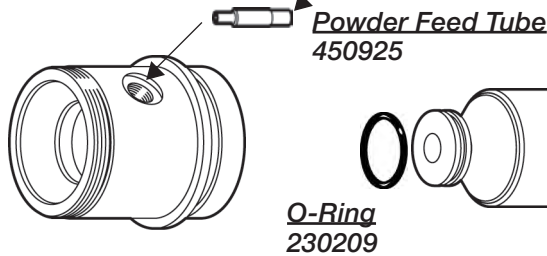
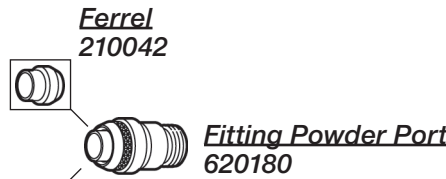
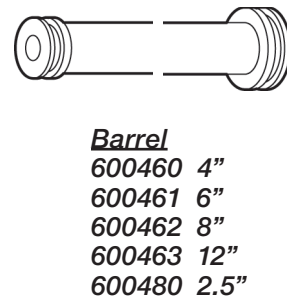
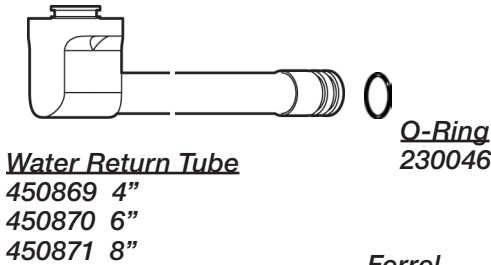

**THERMAL**

American Torch Tip Company (ATTC) is in no way affiliated with above-named manufacturer. References to above-named machines, torches, and numbers are for your reference only. Most parts advertised for sale are made by or for ATTC. Other parts, as indicated, are original parts manufactured by above-named, original equipment manufacturer (OEM) and are simply being resold by ATTC. Footnotes: \* = OEM; # or † = ATTC IS LICENSED TO MAKE AND SELL THIS PART BY NAMED MANUFACTURER; ATTC, ATT SUFFIX, OR - = THIS PART IS AN ORIGINAL ATTC DESIGN AND IS NOT MANUFACTURED IDENTICAL TO THE OEM DESIGN; © INDICATES A REGISTERED TRADEMARK, TRADE NAME, OR PRODUCT NAME OF THE ABOVE-NAMED COMPANY. © COPYRIGHT 2011, AMERICAN TORCH TIP COMPANY



340

Tafa® PRAXAIR®

Tafa® Praxair® ST5000

4" Barrel Assy.  
600635-2

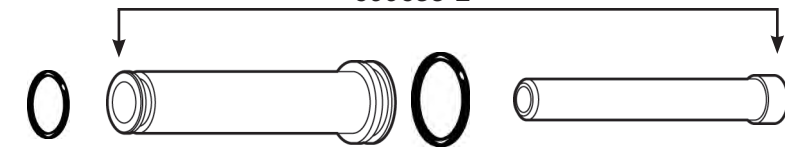

O-Ring  
230261

Outer Barrel  
451560

O-Ring  
230292

Inner Barrel  
451563

Ferrel  
210042

Fitting Powder Port  
620180



Powder Feed Tube  
450925

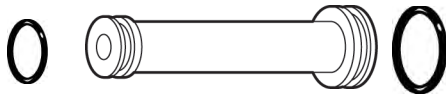

O-Ring  
230261

Barrel  
600636-2

O-Ring  
230292

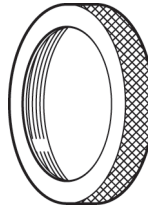

Nut  
450779

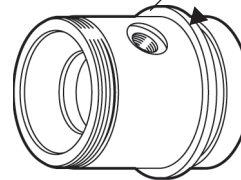

Innerconnector  
451352



O-Ring  
230092



O-Ring  
230208



Combustion Chamber  
451353



Atomizer  
600732 w/O-Ring  
451553 w/out O-Ring

O-Ring  
230304



O-Ring  
230303



American Torch Tip Company (ATTC) is in no way affiliated with above-named manufacturer. References to above-named machines, torches, and numbers are for your reference only. Most parts advertised for sale are made by or for ATTC. Other parts, as indicated, are original parts manufactured by above-named, original equipment manufacturer (OEM) and are simply being resold by ATTC. Footnotes: \* = OEM; # or † = ATTC IS LICENSED TO MAKE AND SELL THIS PART BY NAMED MANUFACTURER; ATTC, ATT SUFFIX, OR - = THIS PART IS AN ORIGINAL ATTC DESIGN AND IS NOT MANUFACTURED IDENTICAL TO THE OEM DESIGN; ® INDICATES A REGISTERED TRADEMARK, TRADE NAME, OR PRODUCT NAME OF THE ABOVE-NAMED COMPANY. © COPYRIGHT 2011, AMERICAN TORCH TIP COMPANY

YOUR SOURCE FOR CONSUMABLE REPLACEMENT PARTS



341

Tafa® PRAXAIR®

Tafa® Praxair® Mogul A-3

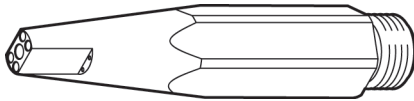

Nozzle  
1323551

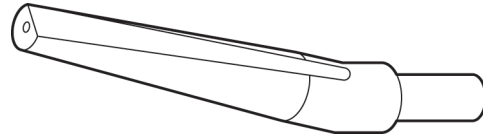

Guide  
1313110

THERMAL

Tafa® Praxair® Plazjet

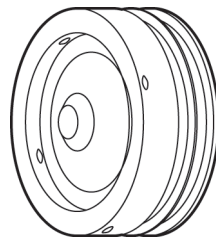

Electrode  
460286

American Torch Tip Company (ATTC) is in no way affiliated with above-named manufacturer. References to above-named machines, torches, and numbers are for your reference only. Most parts advertised for sale are made by or for ATTC. Other parts, as indicated, are original parts manufactured by above-named, original equipment manufacturer (OEM) and are simply being resold by ATTC. Footnotes: \* = OEM; # or † = ATTC IS LICENSED TO MAKE AND SELL THIS PART BY NAMED MANUFACTURER; ATTC, ATT SUFFIX, OR - = THIS PART IS AN ORIGINAL ATTC DESIGN AND IS NOT MANUFACTURED IDENTICAL TO THE OEM DESIGN; ® INDICATES A REGISTERED TRADEMARK, TRADE NAME, OR PRODUCT NAME OF THE ABOVE-NAMED COMPANY. © COPYRIGHT 2011, AMERICAN TORCH TIP COMPANY

941-753-7557 • FAX:941-753-6917 • 800 342-8477 • SALES@ATTCUSA.COM • WWW.AMERICANTORCHTIP.COM





342

Tafa® PRAXAIR®

Tafa® Praxair® SG100

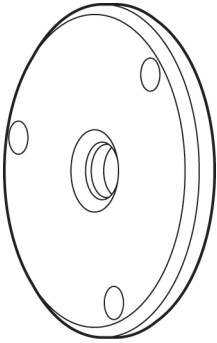

**Front Cover Plate**  
2083-123

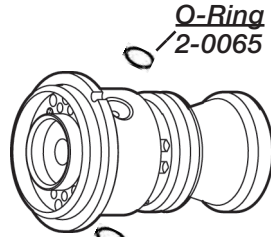

**Anode**  
2083-730ATTC



**O-Ring**  
2-0205



**Injector**  
3083-113



**Cathode**  
1083A-720

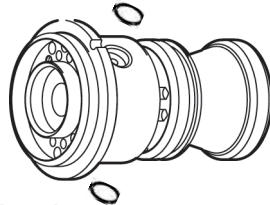

**Anode**  
3083-145 (forward injection)  
3083-175 (straigh injection)  
3083-165 (backward injection)



**O-Ring**  
2-0205

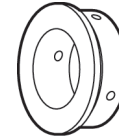

**Injector**  
3083-113

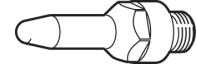

**Cathode**  
1083A-129

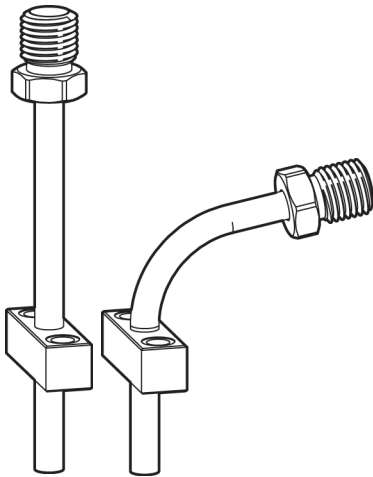

**Powder Injectors**  
5004378-S Straight  
5004378-B Bent

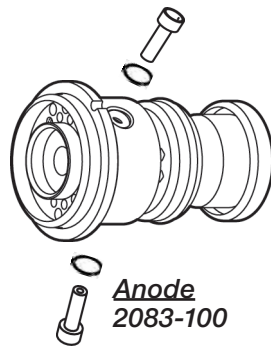

**Anode**  
2083-100



**O-Ring**  
2-0205



**Injector**  
3083-110



**Cathode**  
1083A-104

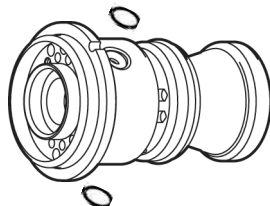

**Anode**  
2083-335 (forward injection)  
2083-358 (straight injection)  
2083-155 (backward injecton)



**O-Ring**  
2-0205

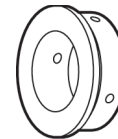

**Injector**  
3083-113

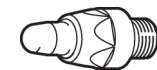

**Cathode**  
1083A-112

American Torch Tip Company (ATTC) is in no way affiliated with above-named manufacturer. References to above-named machines, torches, and numbers are for your reference only. Most parts advertised for sale are made by or for ATTC. Other parts, as indicated, are original parts manufactured by above-named, original equipment manufacturer (OEM) and are simply being resold by ATTC. Footnotes: \* = OEM; # or † = ATTC IS LICENSED TO MAKE AND SELL THIS PART BY NAMED MANUFACTURER; ATTC, ATT SUFFIX, OR - = THIS PART IS AN ORIGINAL ATTC DESIGN AND IS NOT MANUFACTURED IDENTICAL TO THE OEM DESIGN; ® INDICATES A REGISTERED TRADEMARK, TRADE NAME, OR PRODUCT NAME OF THE ABOVE-NAMED COMPANY. © COPYRIGHT 2011, AMERICAN TORCH TIP COMPANY

*Tafa® Praxair® 2086A/SG100 Mini Gun*

**Not Shown**  
L2-17-S O-Ring  
2-21-S O-Ring  
2-22-S O-Ring

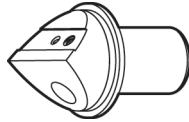

**Anode**  
2084-F45

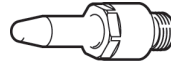

**Cathode**  
3083-129

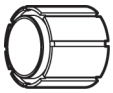

**Gas Distributor**  
2084B-102

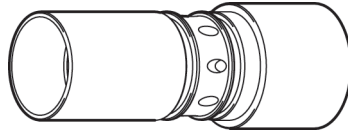

**Insulator Housing**  
2084B-100

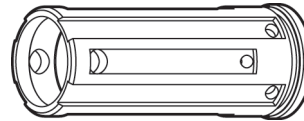

**Water Divider**  
2084B-101



**O-Ring**  
2-19S

**THERMAL**

*Tafa® Praxair® 2700 Mini Gun*

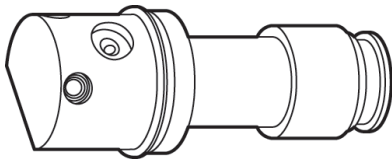

**Anode 14.5°**  
0NSP01391

*Tafa® Praxair® SG200*

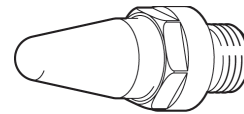

**Cathode**  
1230A-401

American Torch Tip Company (ATTC) is in no way affiliated with above-named manufacturer. References to above-named machines, torches, and numbers are for your reference only. Most parts advertised for sale are made by or for ATTC. Other parts, as indicated, are original parts manufactured by above-named, original equipment manufacturer (OEM) and are simply being resold by ATTC. Footnotes: \* = OEM; # or † = ATTC IS LICENSED TO MAKE AND SELL THIS PART BY NAMED MANUFACTURER; ATTC, ATT SUFFIX, OR - = THIS PART IS AN ORIGINAL ATTC DESIGN AND IS NOT MANUFACTURED IDENTICAL TO THE OEM DESIGN; ® INDICATES A REGISTERED TRADEMARK, TRADE NAME, OR PRODUCT NAME OF THE ABOVE-NAMED COMPANY. © COPYRIGHT 2011, AMERICAN TORCH TIP COMPANY



344

Tafa® PRAXAIR®

Tafa® Praxair® 88XX

THERMAL

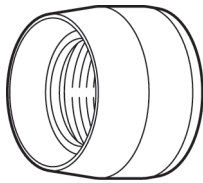

**Retaining Nut**  
600047

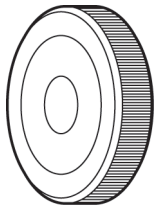

**Wire Drive Roller**  
450010  
600250

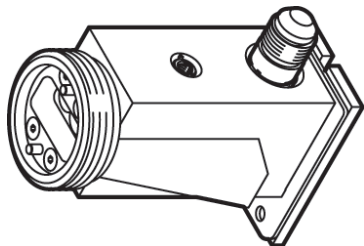

**Alignment Housing**  
600398



For 8860 Gun

**Contact Tip**  
8860-125



**Cap**  
450031 Blue  
450032 Gold  
450033 Green  
450034 Red



**Nozzle Cap**  
450729



**Long Cross Nozzle**  
450028



**Long Slot Nozzle**  
450027



**Short Slot Nozzle**  
620023



**Short Cross Slot**  
620047

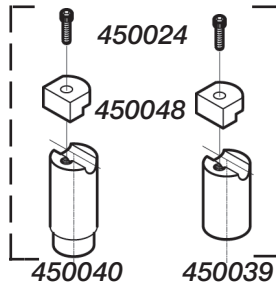

**Complete Assy, Long**  
600136

**Complete Asst. Short**  
600038

**Terminal**  
450024 - Screw  
450039 - Short  
450040 - Long  
450048 - Top

**Not Shown**  
220105 Teflon Conduit  
450979 Contact Tube  
620074 Arc Jet Noz Pos

**Contact Tip**

- 450042 - 1/16
- 450043 - 2 mm
- 450044 - 1/16 Al
- 450045 - 2 Al
- 450289 - 1/16 (I.D.)
- 450303 - .045
- 450458 - 1/16 LL
- 450491 - 1/16 LL, Al
- 450604 2mm LL

**Contact Tip**

- w/2start thread**
- 450067 1/16 Brass
- 450068 1/16 LL

**Contact Tube**

- 450021 88XX
- 450859 9000
- 450022 1/8 (2 start)
- 450023 1/16 (2 start)

**Conduits Ends**

- 450683-1 Long
- 450683 Short

**Long Rear Wire Guide**

600159

**Short Rear Wire Guide**

600158

**Power Lead End Fitting Gun End**  
450302

American Torch Tip Company (ATTC) is in no way affiliated with above-named manufacturer. References to above-named machines, torches, and numbers are for your reference only. Most parts advertised for sale are made by or for ATTC. Other parts, as indicated, are original parts manufactured by above-named, original equipment manufacturer (OEM) and are simply being resold by ATTC. Footnotes: \* = OEM; # or † = ATTC IS LICENSED TO MAKE AND SELL THIS PART BY NAMED MANUFACTURER; ATTC, ATT SUFFIX, OR - = THIS PART IS AN ORIGINAL ATTC DESIGN AND IS NOT MANUFACTURED IDENTICAL TO THE OEM DESIGN; © INDICATES A REGISTERED TRADEMARK, TRADE NAME, OR PRODUCT NAME OF THE ABOVE-NAMED COMPANY. © COPYRIGHT 2011, AMERICAN TORCH TIP COMPANY

**Thermach®**

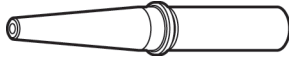

Wire Guide  
840000308 14Ga

**Thermion®**

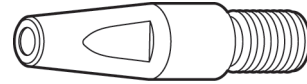

Contact Tip  
50065-1/8  
50065-1/16  
50065-3/16

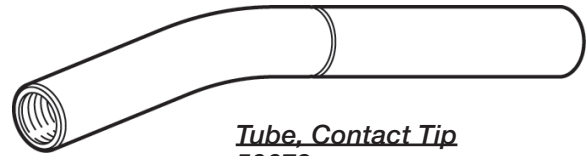

Tube, Contact Tip  
50076

THERMAL

**Wall Colmonoy®**

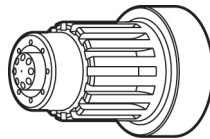

Nozzle  
J-3B  
J-3C

American Torch Tip Company (ATTC) is in no way affiliated with above-named manufacturer. References to above-named machines, torches, and numbers are for your reference only. Most parts advertised for sale are made by or for ATTC. Other parts, as indicated, are original parts manufactured by above-named, original equipment manufacturer (OEM) and are simply being resold by ATTC. Footnotes: \* = OEM; # or † = ATTC IS LICENSED TO MAKE AND SELL THIS PART BY NAMED MANUFACTURER; ATTC, ATT SUFFIX, OR - = THIS PART IS AN ORIGINAL ATTC DESIGN AND IS NOT MANUFACTURED IDENTICAL TO THE OEM DESIGN; © INDICATES A REGISTERED TRADEMARK, TRADE NAME, OR PRODUCT NAME OF THE ABOVE-NAMED COMPANY. © COPYRIGHT 2011, AMERICAN TORCH TIP COMPANY

